

EMI/RFI Shielded Ventilation Panels (3000 Series)

MAJR's line of ready-to-install honeycomb cooling vents provide optimum EMI/RFI shielding with minimum pressure drop for the ventilating air. Shielding effectiveness is accomplished using waveguide design principles.

The choice of the shielded honeycomb that best meets design considerations is based on three main criteria: Shielding, Air Flow and Mounting. For most applications, aluminum Code-32 honeycomb (properly installed using MAJR's mounting frame with integral EMI/RFI gasket) will provide a degree of attenuation that will be within specification limits (See Table 1). However, for the lower frequency range (H-Field) it may be necessary to specify MAJR's material Tin Plated Steel Code-44. Although heavier in weight than aluminum, an increase of 20-40dB H-field shielding effectiveness can be achieved in the lower frequency range by the use of the higher permeable-44 grade.

Common sides and mounting configurations are available. In all cases, the EMI gasket is supplied as an integral part of the vent assembly. Mounting of the vent to a shielded enclosure is accomplished by means of through holes supplied in the panel or captive fasteners located and installed to specific dimensions.

Design Data

EMI/RFI Shielding

Shielding Effectiveness vs Frequency — Table 1

CHROMATE FINISH

Field	Aluminum Material Code - 32						
	Frequency						
	100 kHz	1 MHz	18 MHz	100 MHz	400 MHz	1 GHz	10 GHz
H	35	50	—	—	—	—	—
E	—	—	75	—	—	—	—
PW	—	—	—	75	75	65	50

The data in Table 1 shows shielding characteristics for standard MAJR shielded vents. Note that the data indicated is based on a unit whose opening was 12.00 x 12.00 (305 x 305 mm) and tested under laboratory conditions per MIL-STD 285.

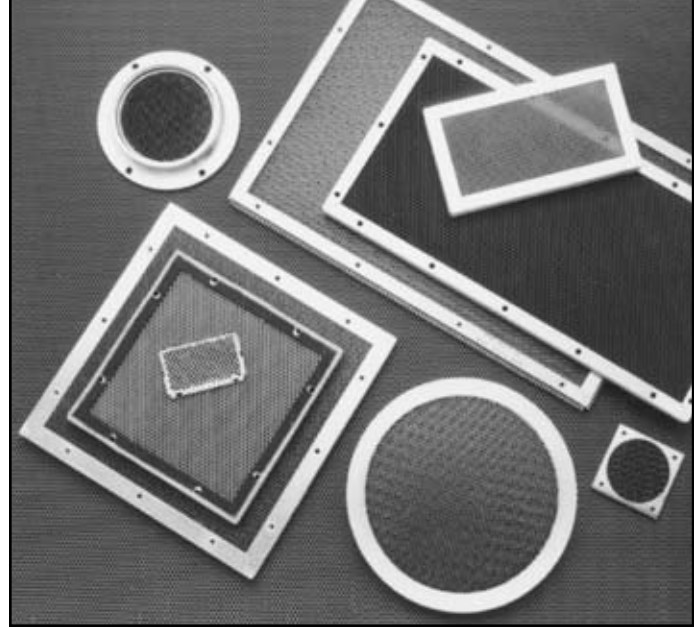

Features

- Ease of Installation**
 Shielded air vents are supplied with EMI gasket and mounting holes or captive fasteners so as to be ready for installation into the cabinet.
- Special Designs**
 MAJR's engineering group can assist with applications requiring special mounting or shape.
- Painted Units**
 Vents mounted on the outside of cabinet can be supplied with exposed surfaces painted to meet the Military Standard color of the cabinet.
- Optimum Shielding and Air Flow**
 Installation of the honeycomb — with its 4:1 opening to depth ratio — provides the waveguide below cut-off effect required to attenuate EMI/RFI interference while not impeding the air flow required to cool the packaged enclosure.
- Standard Configurations**
 A broad selection of sides provides the widest choice in meeting design objectives.
- RoHS Compliant**

Table 1 (Continued)

Field	Aluminum Tin Plate Material Code - 42						
	Frequency						
	100 kHz	1 MHz	18 MHz	100 MHz	400 MHz	1 GHz	10 GHz
H	65	80	—	—	—	—	—
E	—	—	100	—	—	—	—
PW	—	—	—	95	95	95	90

Field	Steel Tin Plate Material Code - 44						
	Frequency						
	100 kHz	1 MHz	18 MHz	100 MHz	400 MHz	1 GHz	10 GHz
H	75	80	—	—	—	—	—
E	—	—	110	—	—	—	—
PW	—	—	—	110	110	110	100

Air Flow Resistance — Figure 1

The low resistance to air flow of MAJR'S shielded honeycomb panels will minimize pressure drop within cabinet, allowing air to move freely through the intake and exhaust to perform the desired cooling function. The curves in Figure 1 show the resistance per square inch for standard honeycomb vents.

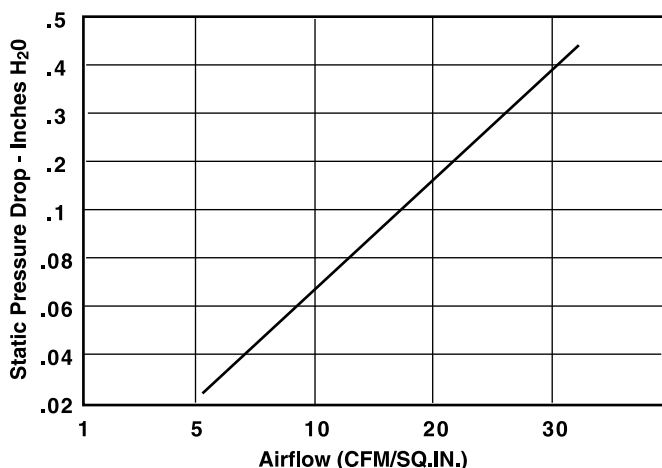

Mounting Installation

Four mounting frames are offered as a standard for installation into the cabinet. In each case, the extruded aluminum frame is designed with a "tooth" that bites into the honeycomb to ensure grounding of the frame to the honeycomb. (See Figure 2).

Figure 2

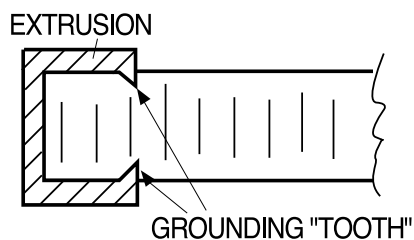

Figures 3 through 5 depict the frames offered as standard mounting configurations. Although these frames represent those sections that are most popular, MAJR offers a wide range of shapes for those applications requiring special mounting.

Figure 3 - Style 3031 Through Hole

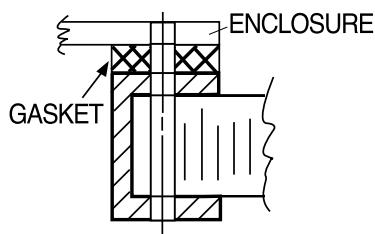

Figure 4 - Style 3032 Captive Fastener

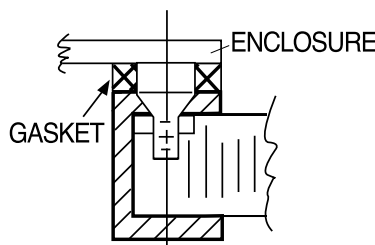

Figure 5 - Style 3036 Recess Mount

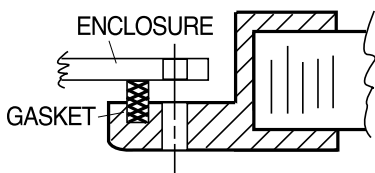

Figure 6 -Style 3031 EMI/RFI Shielded Ventilation Panel with Through Holes

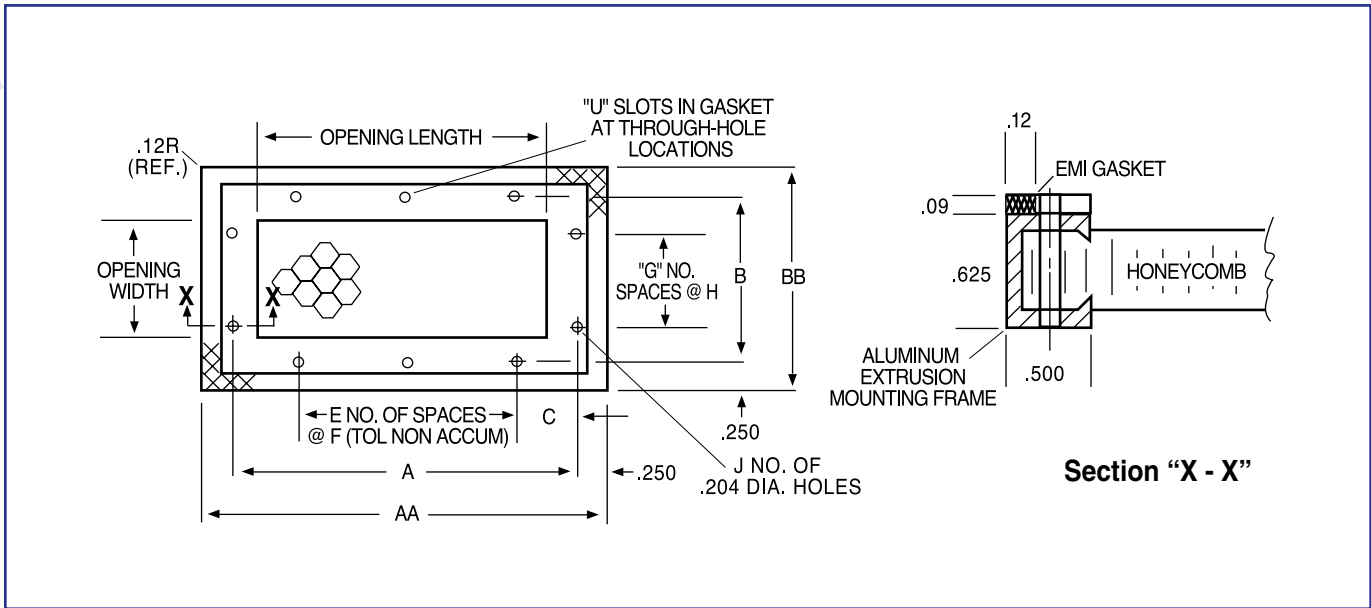

Table 2

OPENING		Part Number -32 Material	FRAME DIMENSIONS										
Width	Length		AA	BB	A	B	C	D	E	F	G	H	J
3.00 (76.2)	3.00 (76.2)	3031-20303-xx	4.00 (101.6)	4.00 (101.6)	3.50 (88.9)	3.50 (88.9)	1.75 (44.5)	1.75 (44.5)	—	—	—	—	4
3.00 (76.2)	5.00 (127.0)	3031-20305-xx	6.00 (152.4)	4.00 (101.6)	5.50 (139.7)	3.50 (88.9)	1.00 (25.4)	1.75 (44.5)	1	3.50 (88.9)	—	—	6
3.00 (76.2)	11.00 (279.4)	3031-20311-xx	12.00 (304.8)	4.00 (101.6)	11.50 (292.1)	3.50 (88.9)	1.25 (31.8)	1.75 (44.5)	3	3.00 (76.2)	—	—	10
4.00 (101.6)	4.00 (101.6)	3031-20404-xx	5.00 (127.0)	5.00 (127.0)	4.50 (114.3)	4.50 (114.3)	.750 (19.1)	2.25 (57.2)	1	3.00 (76.2)	—	—	6
4.00 (101.6)	9.00 (228.6)	3031-20409-xx	10.00 (254.0)	5.00 (127.0)	9.50 (241.3)	4.50 (114.3)	1.25 (31.8)	2.25 (57.2)	2	3.50 (88.9)	—	—	8
5.00 (127.0)	5.00 (127.0)	3031-20505-xx	6.00 (152.4)	6.00 (152.4)	5.50 (139.7)	5.50 (139.7)	1.00 (25.4)	1.00 (25.4)	1	3.50 (88.9)	1	3.50 (88.9)	8
5.00 (127.0)	11.00 (279.4)	3031-20511-xx	12.00 (304.8)	6.00 (152.4)	11.50 (292.1)	5.50 (139.7)	1.25 (31.8)	1.00 (25.4)	3	3.00 (76.2)	1	3.50 (88.9)	12
6.00 (152.4)	6.00 (152.4)	3031-20606-xx	7.00 (177.8)	7.00 (177.8)	6.50 (165.1)	6.50 (165.1)	1.50 (38.1)	1.50 (38.1)	1	3.50 (88.9)	1	3.50 (88.9)	8
6.00 (152.4)	9.00 (228.6)	3031-20609-xx	10.00 (254.0)	7.00 (177.8)	9.50 (241.3)	6.50 (165.1)	1.25 (31.8)	1.50 (38.1)	2	3.50 (88.9)	1	3.50 (88.9)	10
7.00 (177.8)	14.00 (355.6)	3031-20714-xx	15.00 (381.0)	8.00 (203.2)	14.50 (368.3)	7.50 (190.5)	.750 (19.1)	.750 (19.1)	4	3.25 (82.6)	2	3.00 (76.2)	16
9.00 (228.6)	9.00 (228.6)	3031-20909-xx	10.00 (254.0)	10.00 (254.0)	9.50 (241.3)	9.50 (241.3)	1.25 (31.8)	1.25 (31.8)	2	3.50 (88.9)	2	3.50 (88.9)	12
11.00 (279.4)	11.00 (279.4)	3031-21111-xx	12.00 (304.8)	12.00 (304.8)	11.50 (292.1)	11.50 (292.1)	1.25 (31.8)	1.25 (31.8)	3	3.00 (76.2)	3	3.00 (76.2)	16
14.00 (355.6)	14.00 (355.6)	3031-21414-xx	15.00 (381.0)	15.00 (381.0)	14.50 (368.3)	14.50 (368.3)	1.25 (31.8)	1.25 (31.8)	4	3.00 (76.2)	4	3.00 (76.2)	20
18.00 (457.2)	18.00 (457.2)	3031-21818-xx	19.00 (482.6)	19.00 (482.6)	18.50 (469.9)	18.50 (469.9)	1.75 (44.5)	1.75 (44.5)	5	3.00 (76.2)	5	3.00 (76.2)	24

xx = Require Finish
 3031-20303-32 — Ventilation Panel with Chromate Finish