

# 5210 Series Track Mounting

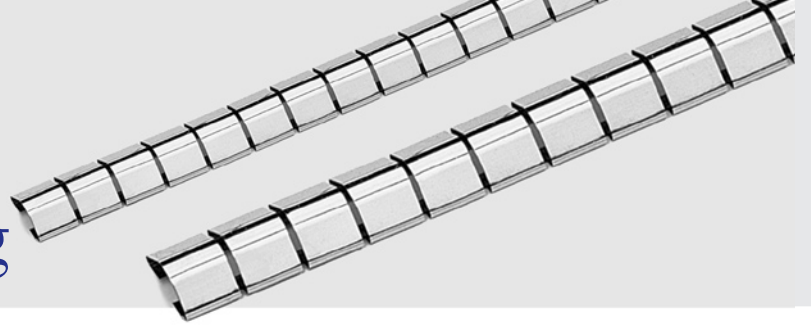

## 5210-01A32-XX

### SYMMETRICAL

#### Compression Force

	25% Compression (0.075")	50% Compression (0.050")
Standard	9.1 lbs/ft	18.1 lbs/ft

Note: For use with Track TR52.

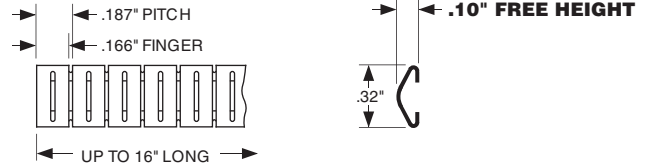

Consult factory for the availability of longer lengths.

## 5210-01D60-XX

### SYMMETRICAL

#### Compression Force

	25% Compression (0.165")	50% Compression (0.110")
Standard	11 lbs/ft	27 lbs/ft
"TF" Style	4.0 lbs/ft	10 lbs/ft

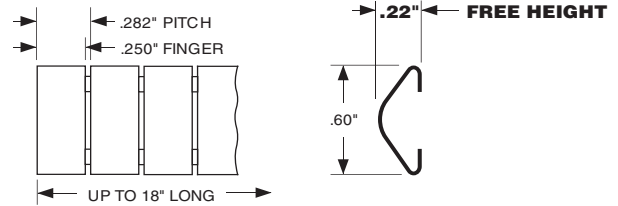

# 5220 Series Snap-on Mounting

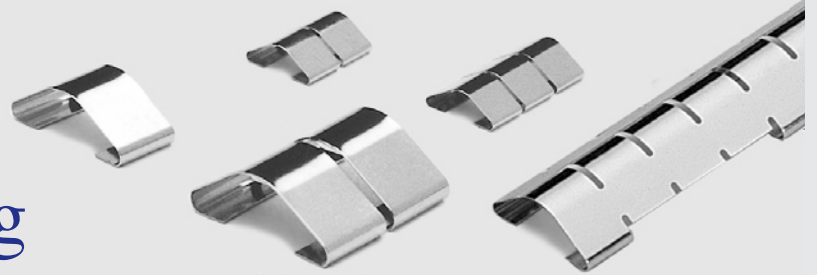

## 5220-02C32-XX

### SYMMETRICAL

#### GAP RANGE UP TO .06"

#### Compression Force

	25% Compression (0.053")	50% Compression (0.035")
Standard	2.7 lbs/ft	14 lbs/ft
"TF" Style	2.5 lbs/ft	6.5 lbs/ft

#### APPLICATION DATA

Note:

1. \*Actual length determined by finger pattern.

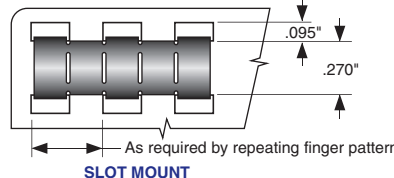
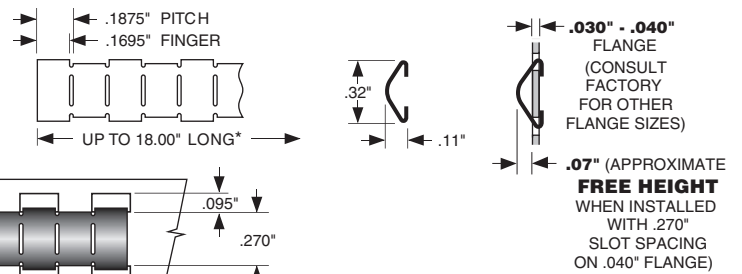

SLOT MOUNT

## 5220-03C32-XX

### SYMMETRICAL

#### GAP RANGE UP TO .06"

#### Compression Force

	25% Compression (0.053")	50% Compression (0.035")
Standard	4.1 lbs/ft	14 lbs/ft
"TF" Style	1.1 lbs/ft	1.3 lbs/ft

#### APPLICATION DATA

Note:

1. \*Actual length determined by finger pattern.

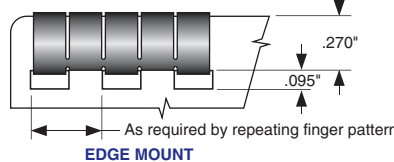
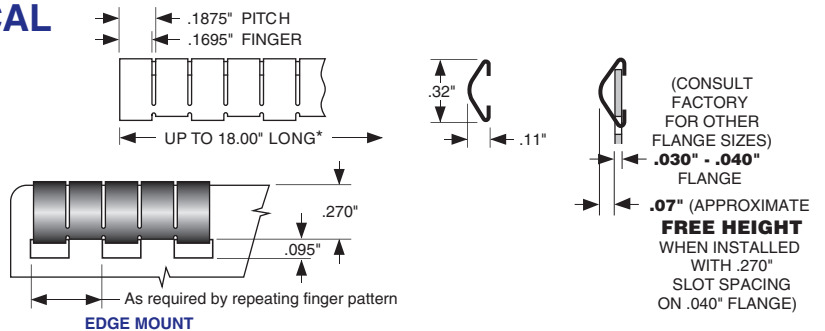

EDGE MOUNT

# 5220 Series Snap-on Mounting

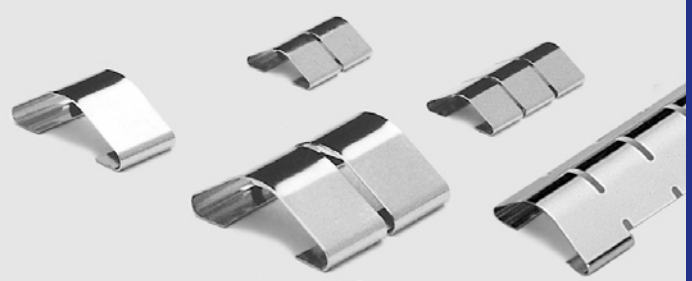

## 5220-05D37-XX SYMMETRICAL

**GAP RANGE UP TO .075"**

Standard

### APPLICATION DATA

Notes:

1. Length of slot as required by number of fingers.
2. Spacing determined by attenuation requirements.

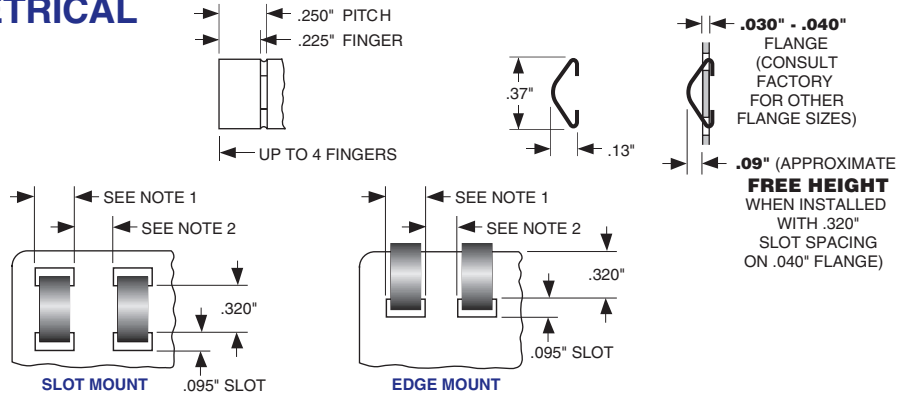

## 5220-06D37-XX SYMMETRICAL

**GAP RANGE UP TO .075"**

### Compression Force

	25% Compression (0.068")	50% Compression (0.045")
Standard	1.3 lbs/ft	6.9 lbs/ft

### APPLICATION DATA

Note:

1. \*Actual length determined by finger pattern.

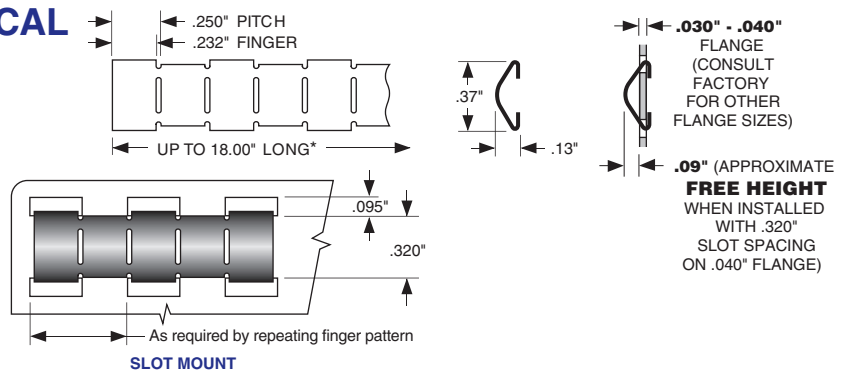

## 5220-07D37-XX SYMMETRICAL

**GAP RANGE UP TO .075"**

### Compression Force

	25% Compression (0.068")	50% Compression (0.045")
Standard	1.5 lbs/ft	4.1 lbs/ft

### APPLICATION DATA

Note:

1. \*Actual length determined by finger pattern.

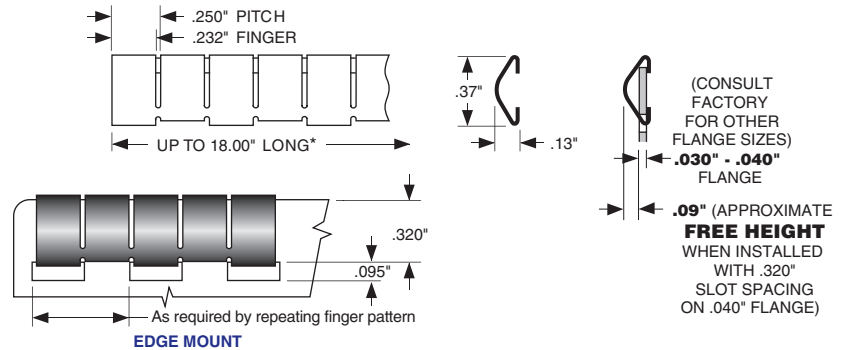

## 5220-08G60-XX SYMMETRICAL

**GAP RANGE UP TO .113"**

Standard  
"TF" Style

